

Schweden / 50 / 08

6150

700

1500

3750

345 810 345

1275

1200

1275

3550

1200

140x195

81x91

81x91

120x91

86x195

70x195

81x91

GRUNDPLAN

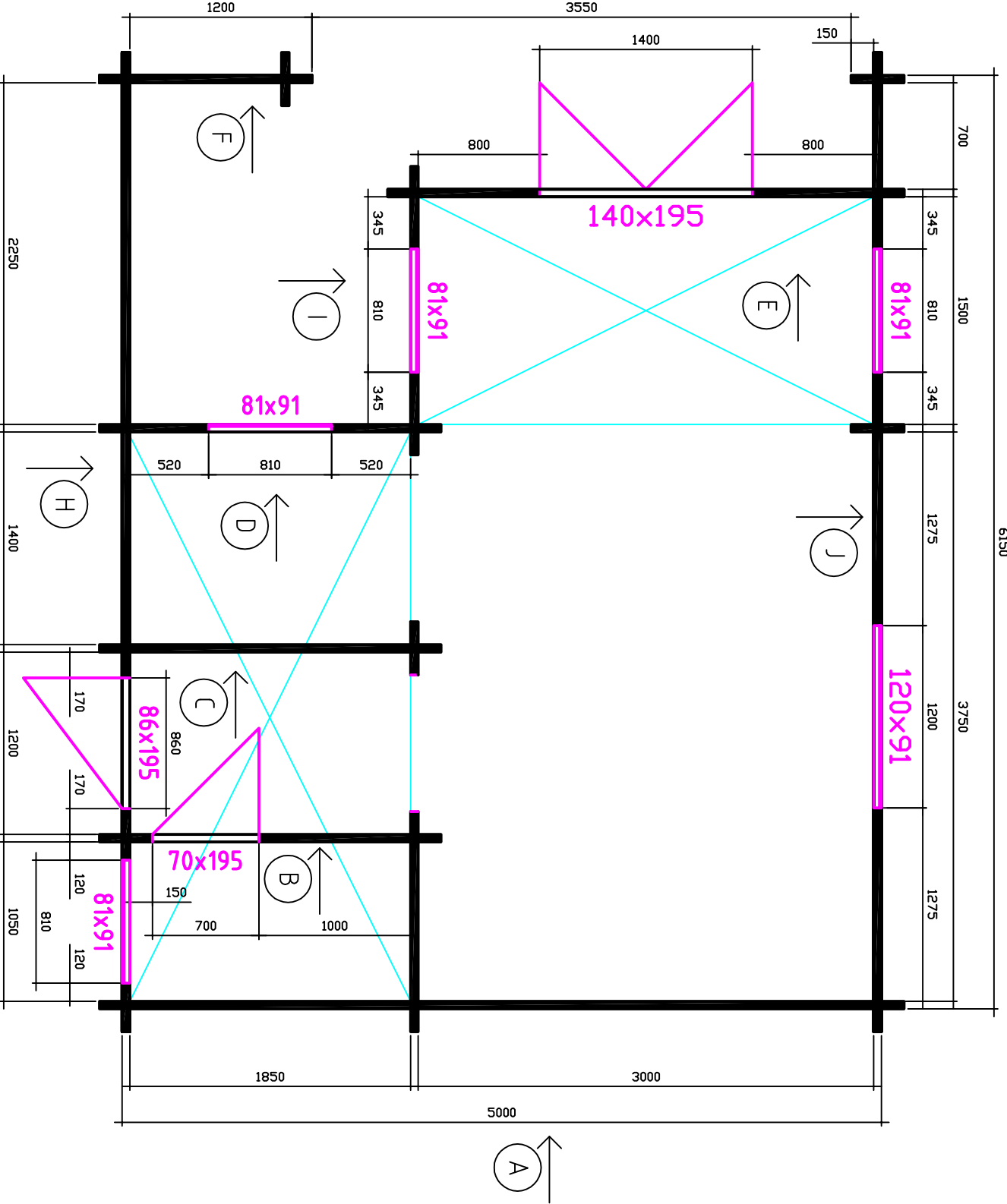

Schweden / 50 / 08

6140

6004

654

1482

3732

4990

AR2

2954

AR3

1832

AR3

AR3

AR3

AR6

AR9

AR9

AR9

AR9

AR9

AR6

AR8

AR7

AR7

AR7

AR8

1396

AR3

AR4

AR4

AR4

1182

AR3

AR5

AR5

AR5

1018

AR2

AR8

AR1

AR1

AR1

AR1

AR1

FUNDAMENT

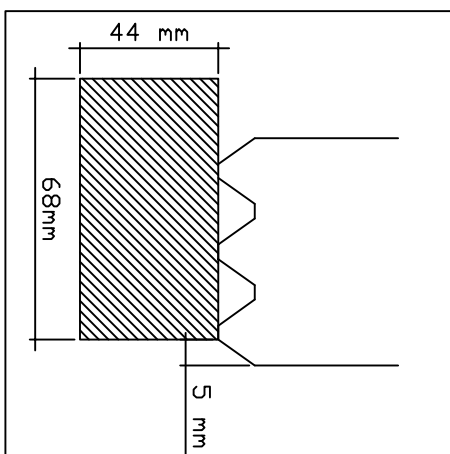

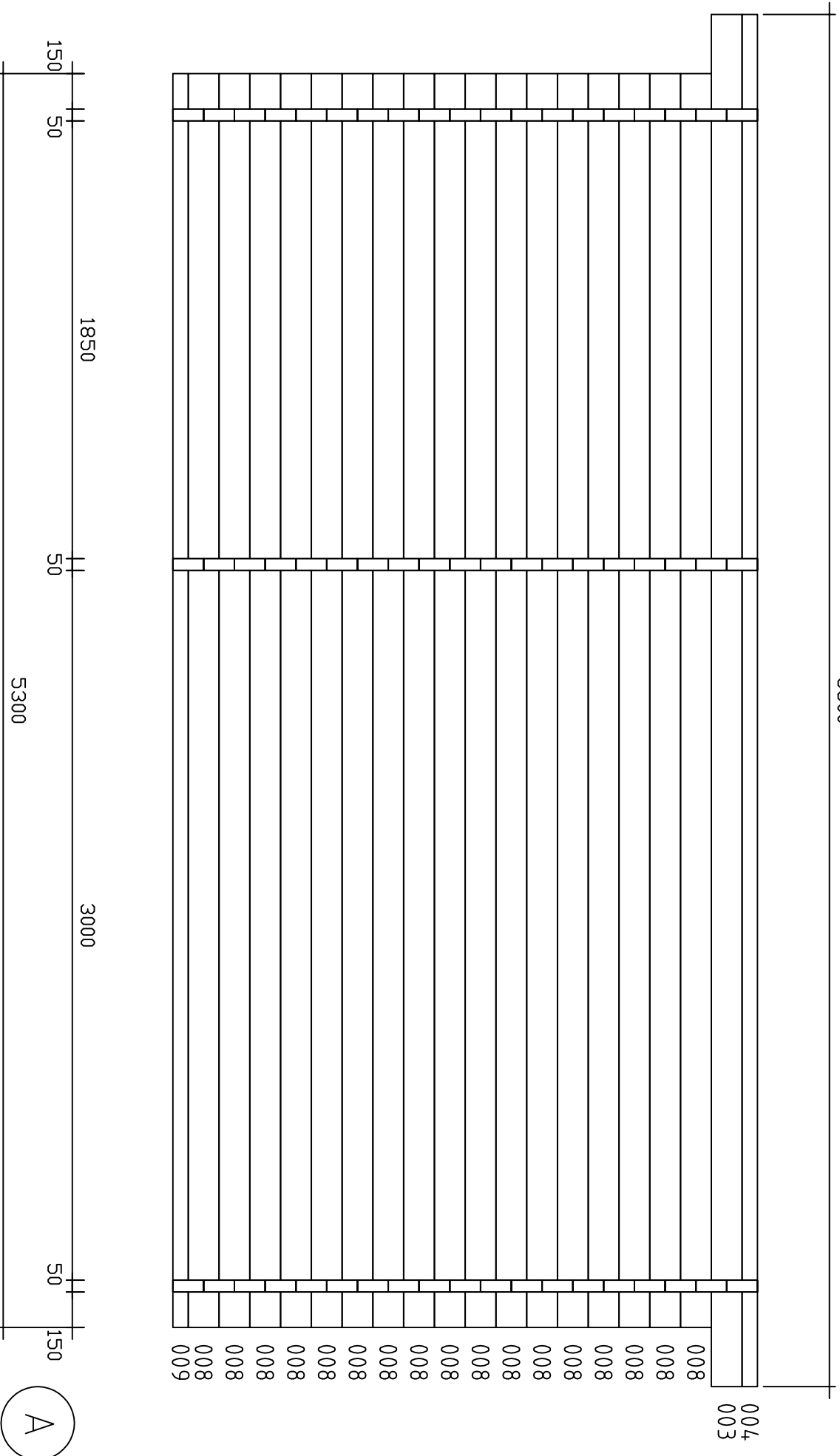

Feder ab.

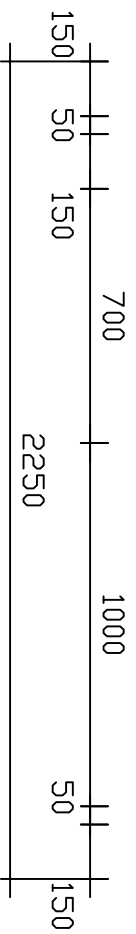
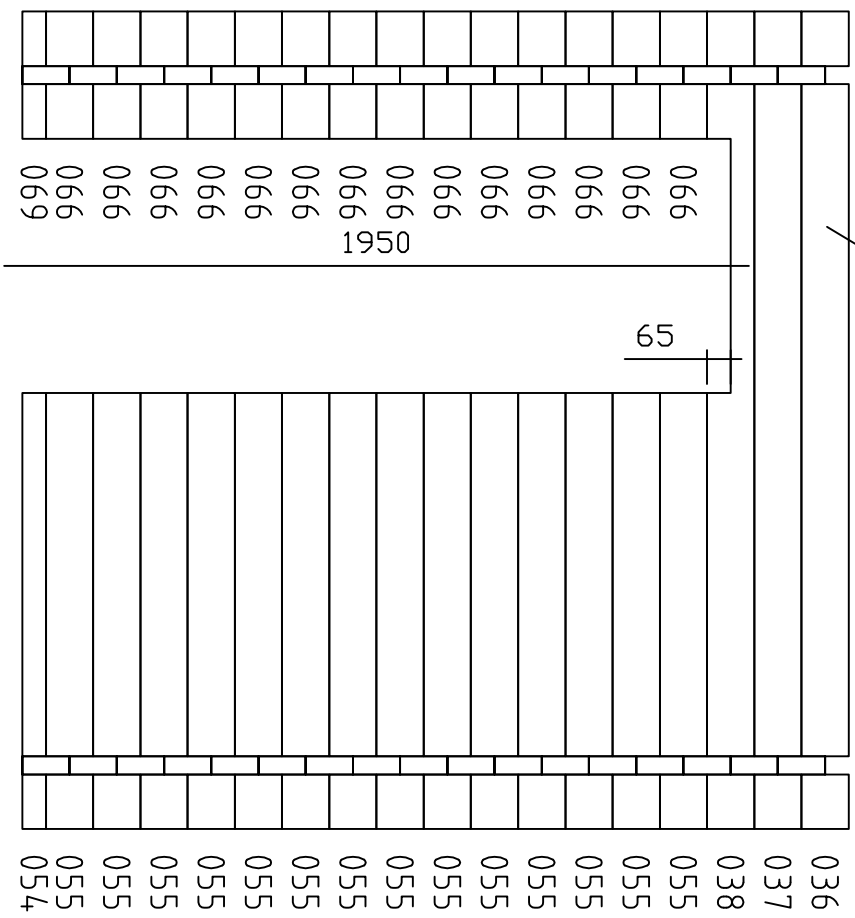

Schweden / 50 / 08

B

Feder ab.

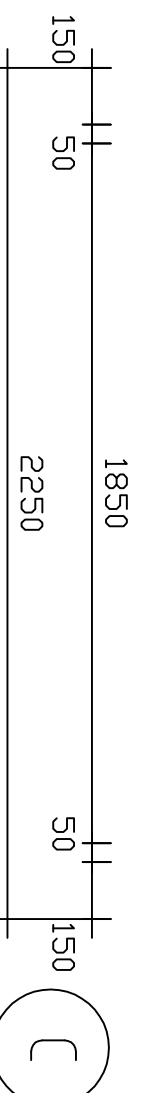
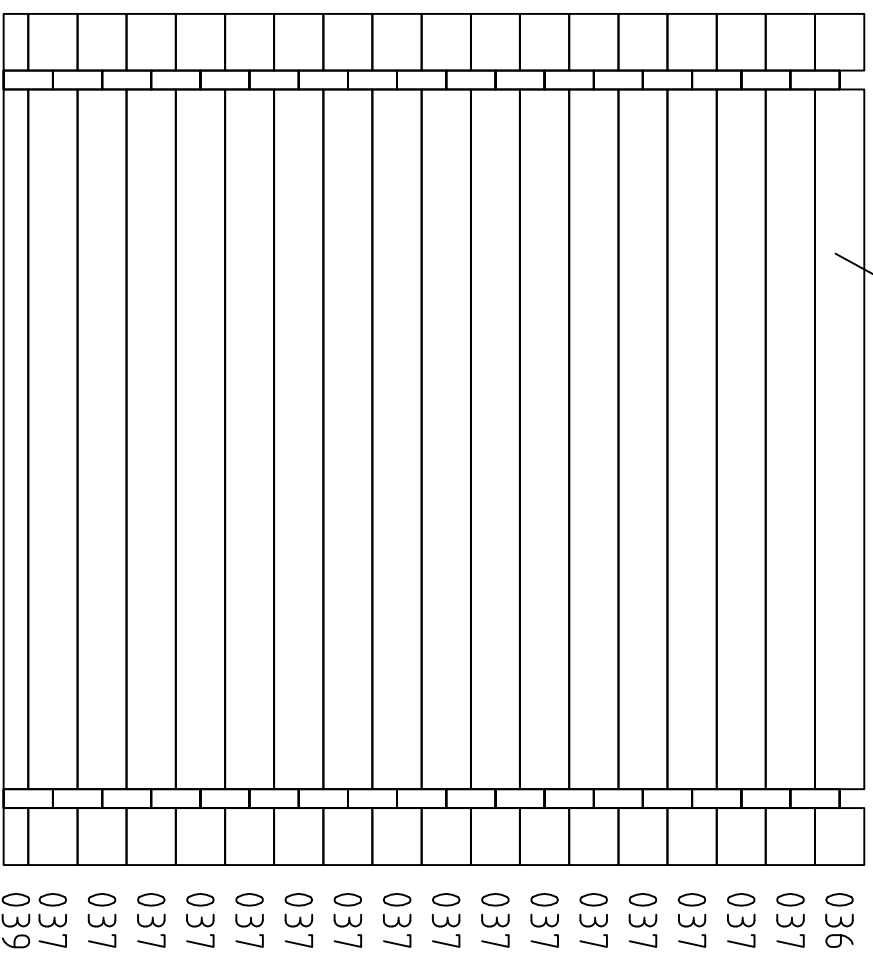

Schweden / 50 / 08

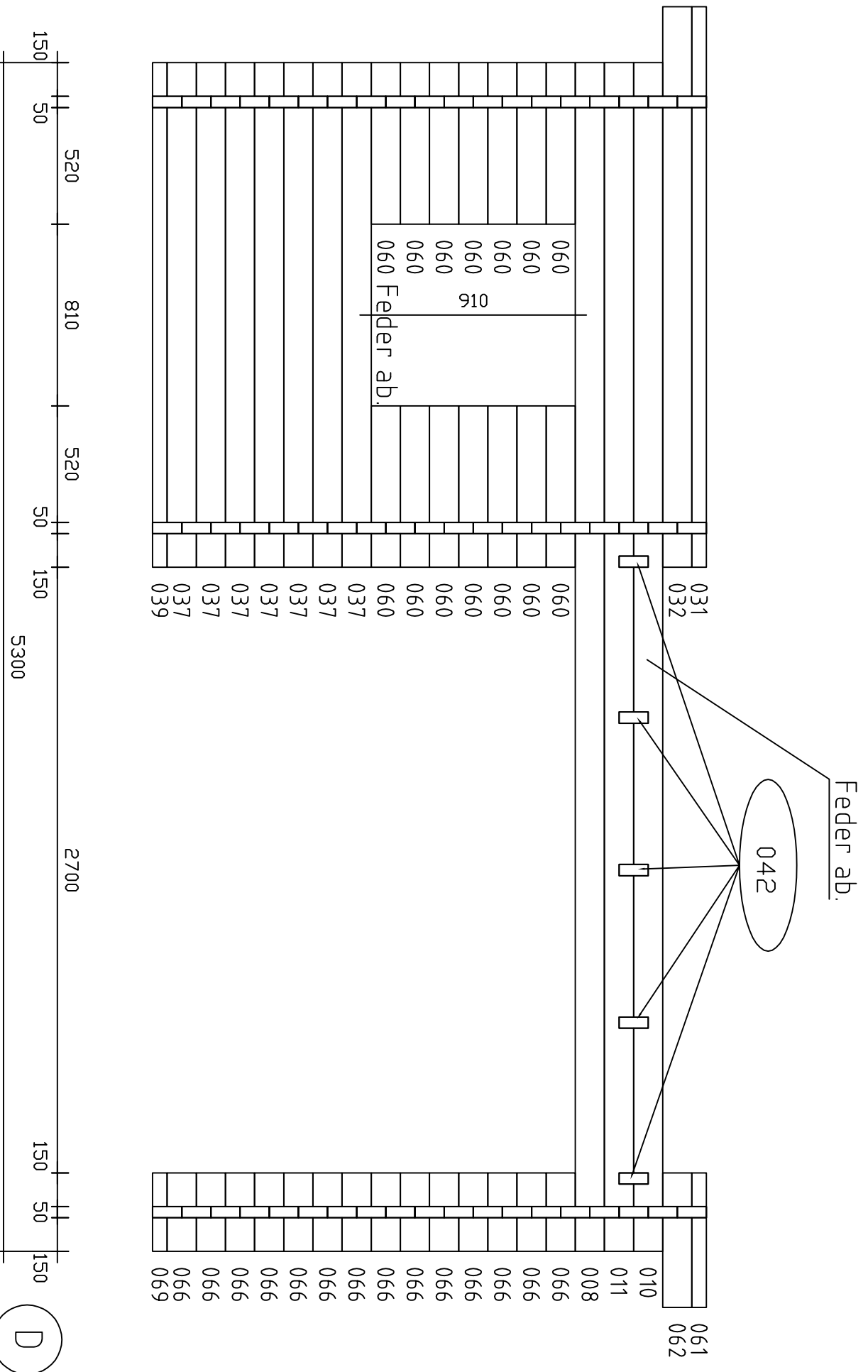

Schweden / 50 / 08

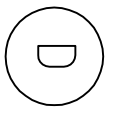

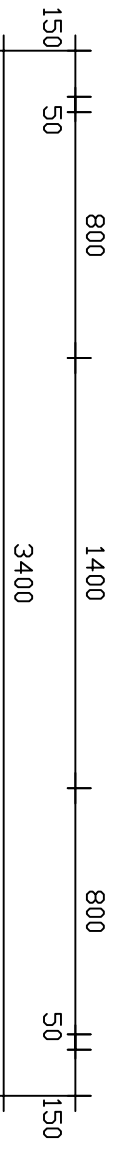
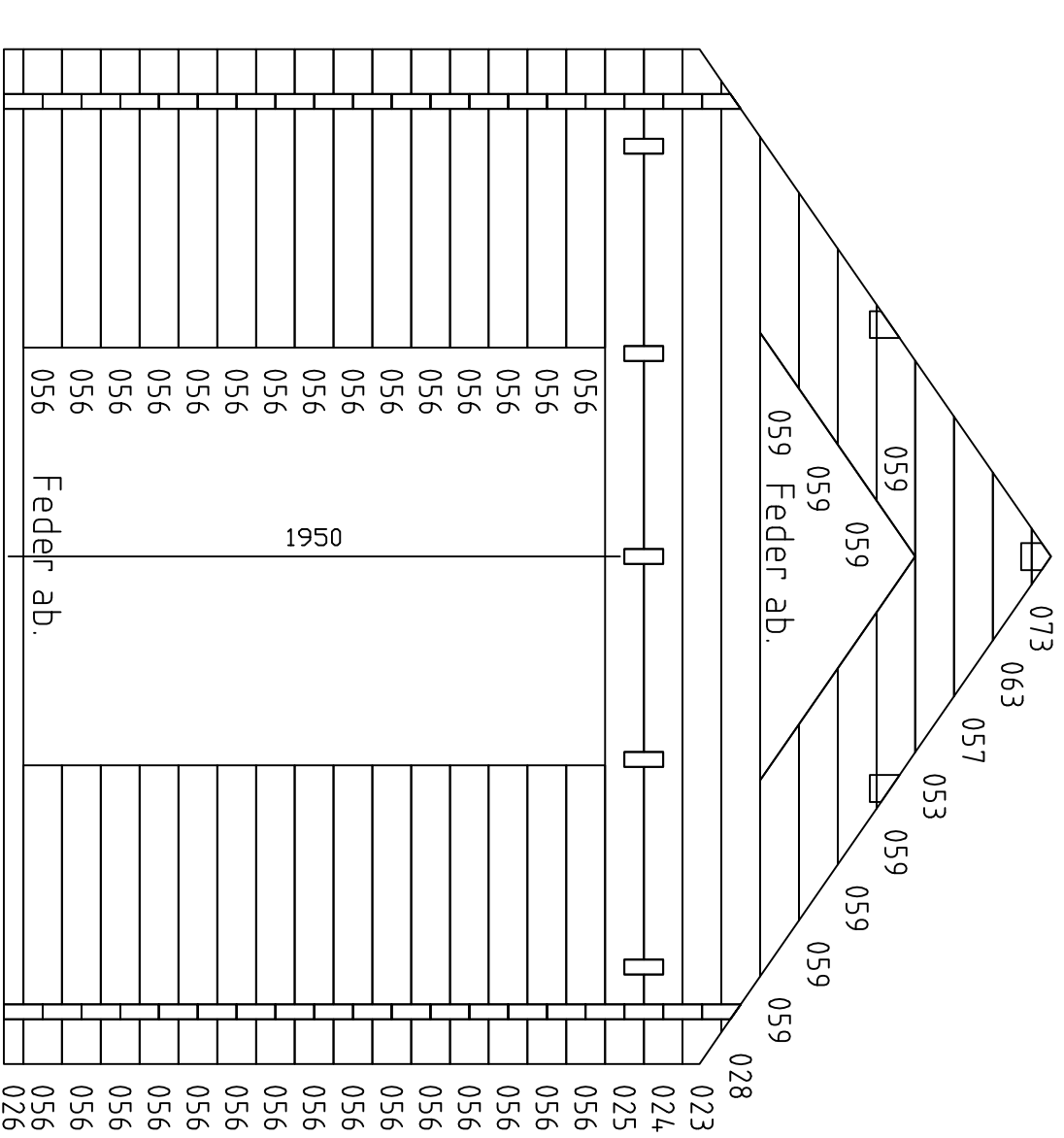

E

Schweden / 50 / 08

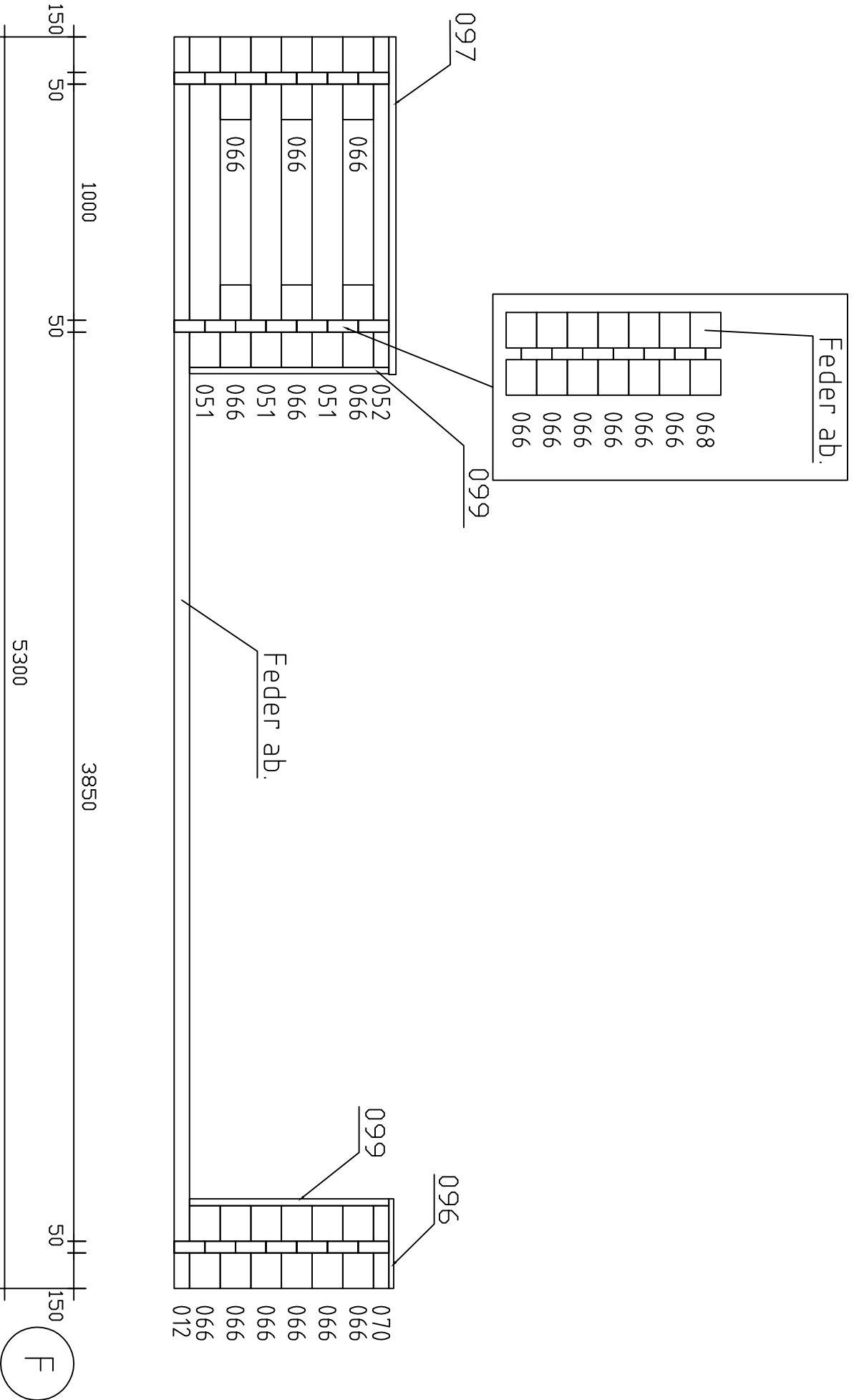

Schweden / 50 / 08



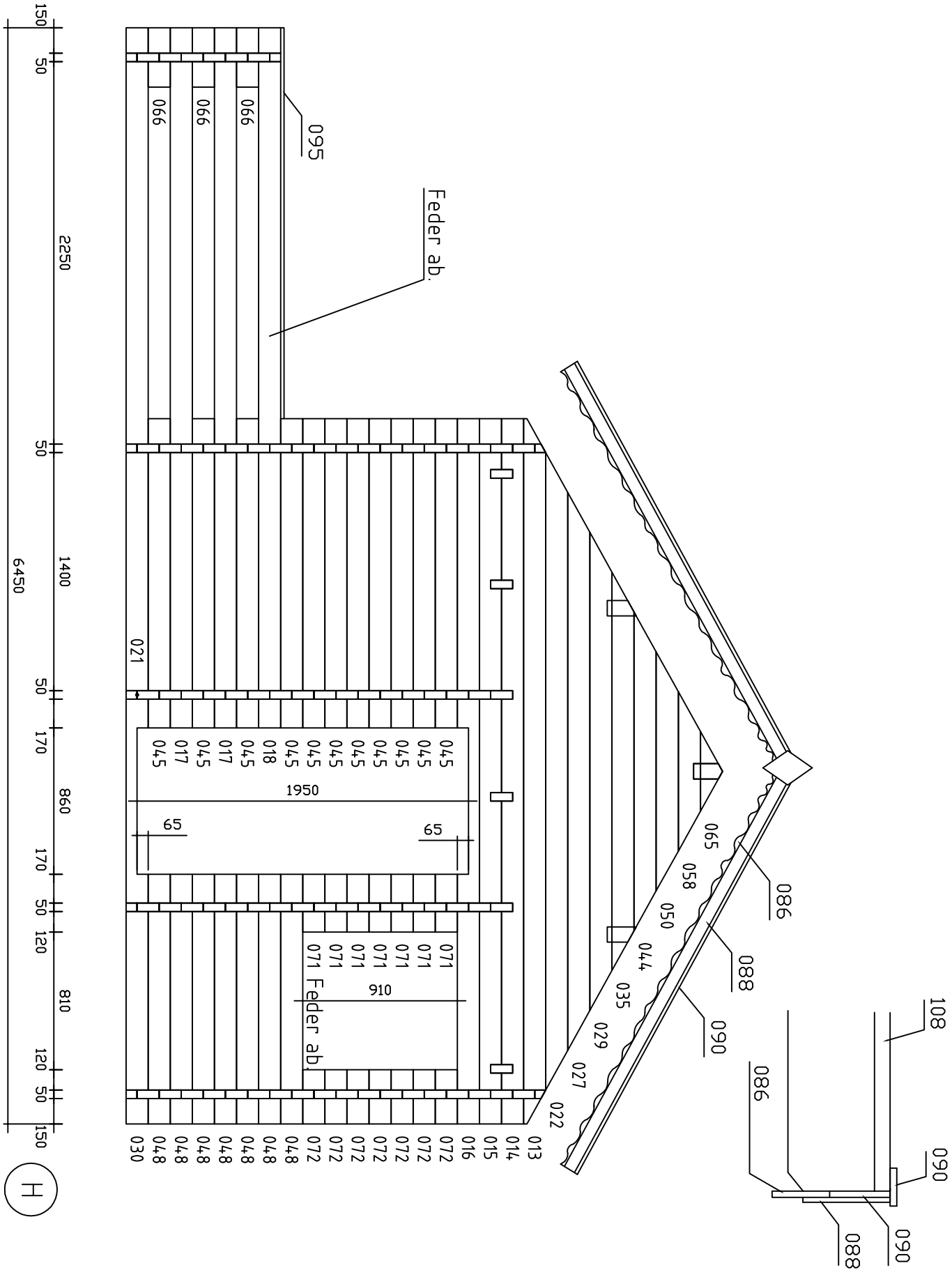

Schweden / 50 / 08

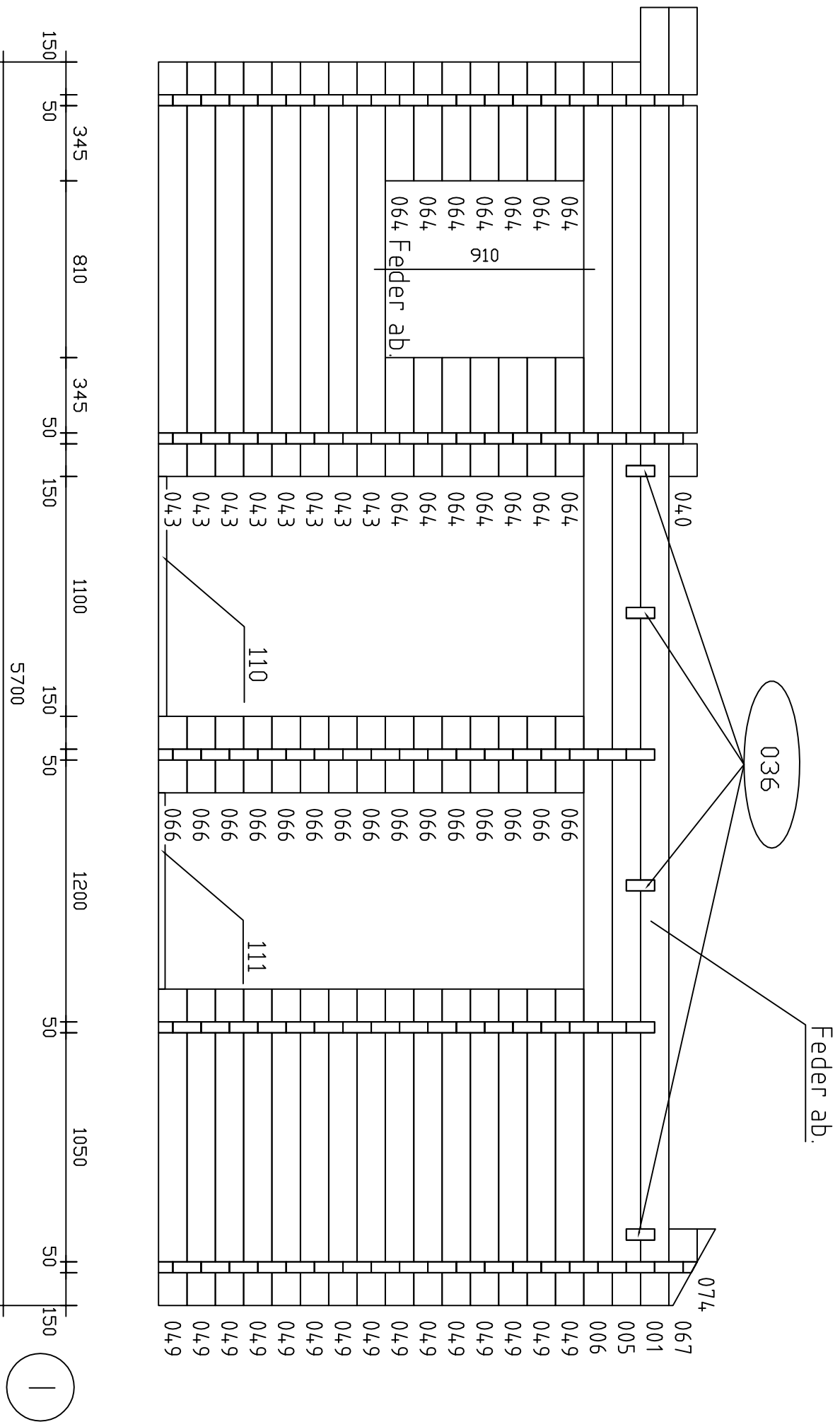



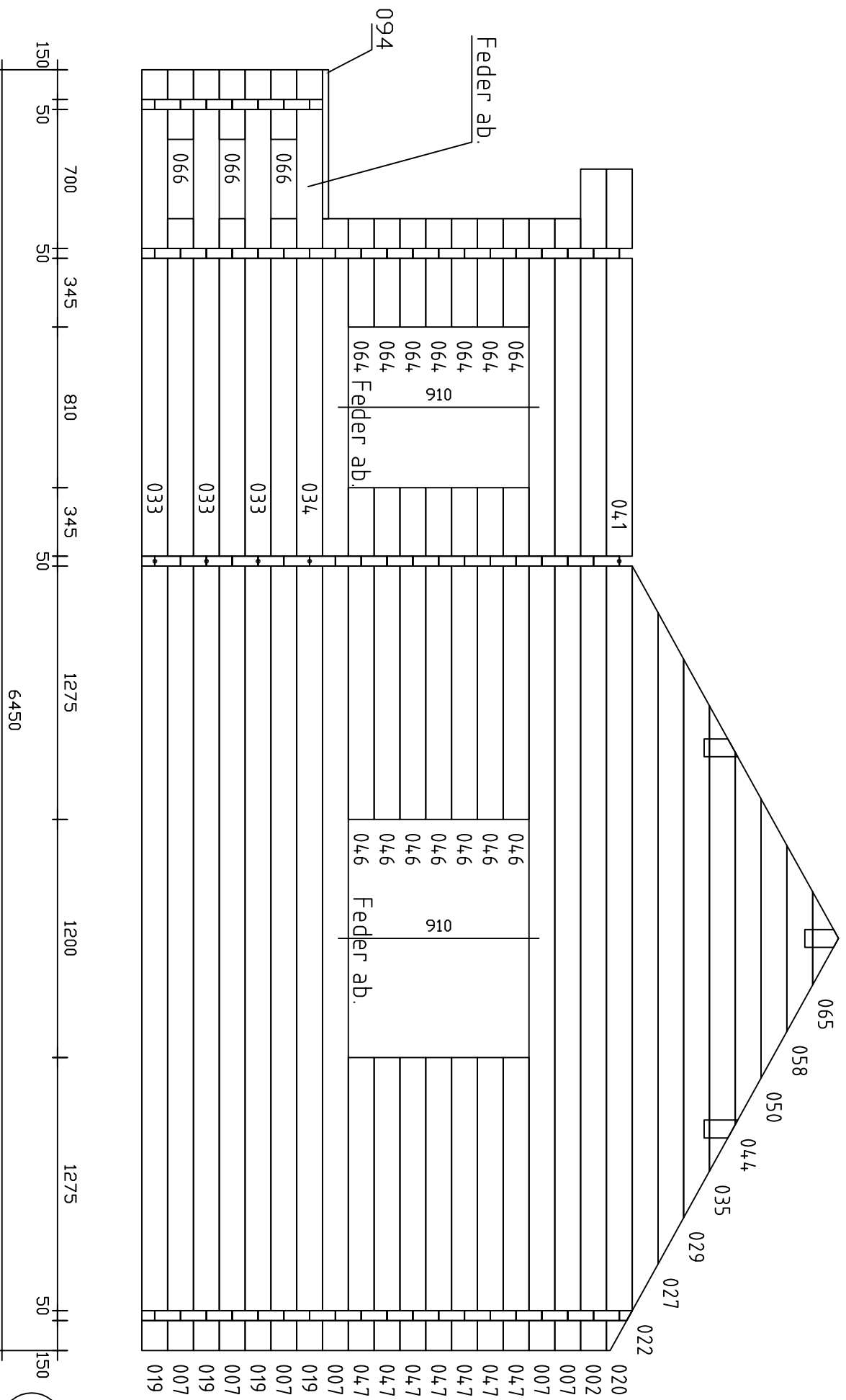

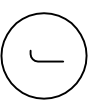

Schweden / 50 / 08



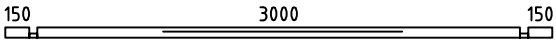
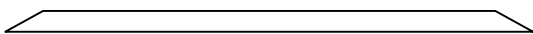
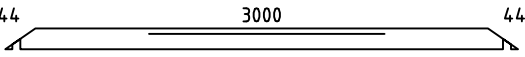
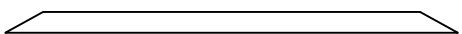
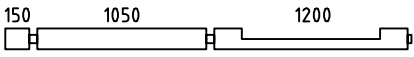
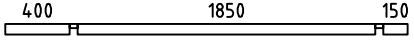
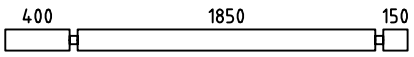
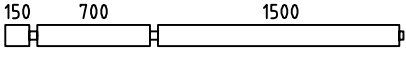
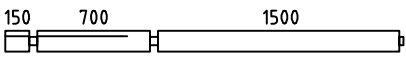
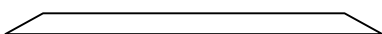
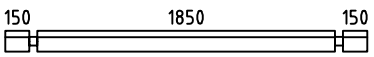

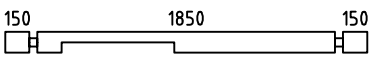
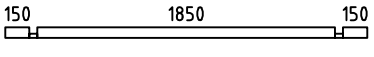
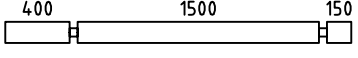
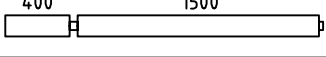
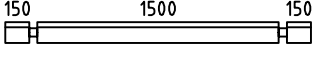

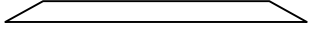
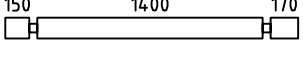
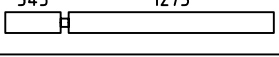
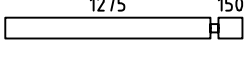

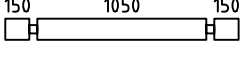
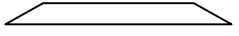

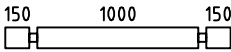
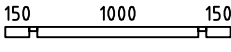
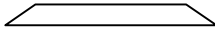
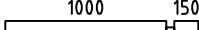
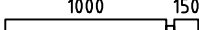
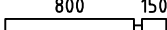
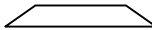
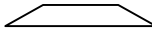
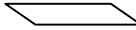
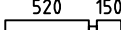
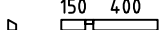
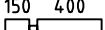













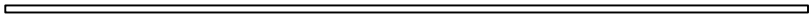
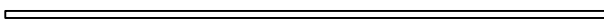

Schweden / 50 / 08





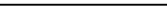
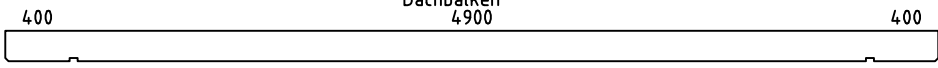
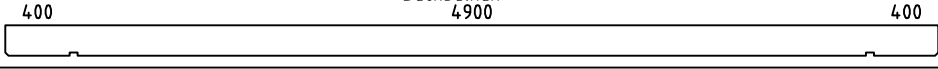
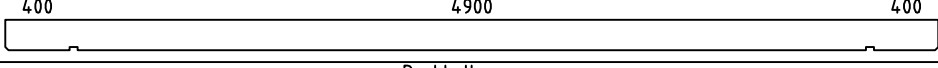
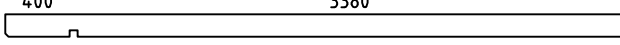
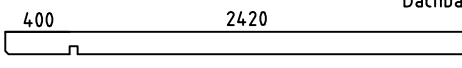
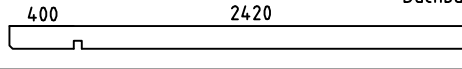
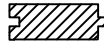



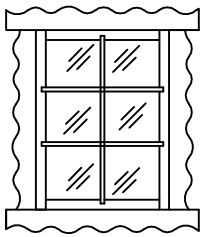

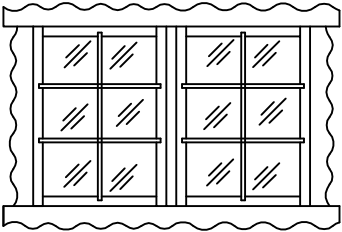
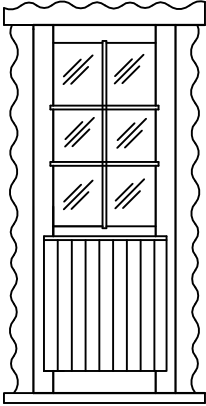
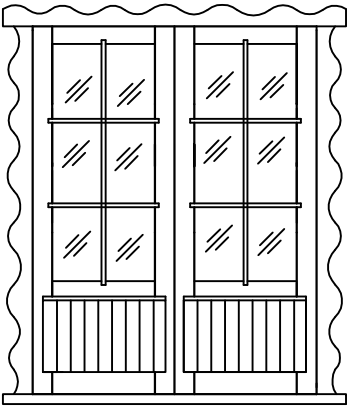
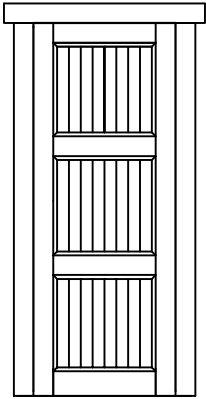
Pos	Schweden / 50 / 08	ST	F (mm)	L (mm)
001		1	50x130	5950
002		1	50x130	5950
003		1	50x130	5800
004		1	50x65	5800
005		1	50x130	5700
006		1	50x130	5700
007		5+1	50x130	5700
008		18	50x130	5300
009		1	50x65	5300
010		1	50x130	5300
011		1	50x130	5300
012		1	50x65	5300
013		1	50x130	4150
014		1	50x130	4150
015		1	50x130	4150
016		1	50x130	4150
017		2	50x130	4120
018		1	50x130	4120
019		4	50x130	3975
020		1	50x130	3975
021		1	50x130	3925
022		2	50x130	3750
023		1	50x130	3400
024		1	50x130	3400
025		1	50x130	3400

Pos	Schweden / 50 / 08	ST	F (mm)	L (mm)
026		1	50x65	3400
027		2	50x130	3281
028		1	50x130	3188
029		2	50x130	2812
030		1	50x130	2525
031		1	50x65	2500
032		1	50x130	2500
033		3	50x130	2475
034		1	50x130	2475
035		2	50x130	2344
036		6	50x130	2250
037		23+1	50x130	2250
038		1	50x130	2250
039		2	50x65	2250
040		1	50x130	2150
041		1	50x130	1975
042		5	50x130	1900
043		7+1	50x130	1900
044		2	50x130	1875
045		11	50x130	1820
046		7	50x130	1670
047		7	50x130	1475
048		6+1	50x130	1470
049		15	50x130	1450
050		2	50x130	1406

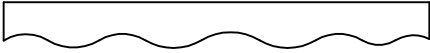
Pos	Schweden / 50 / 08	ST	F (mm)	L (mm)	
051		3	50x130	1400	
052		1	50x65	1400	
053		1	50x130	1312	
054		1	50x65	1200	
055		14	50x130	1200	
056		30	50x130	1000	
057		1	50x130	937	
058		2	50x130	937	
059		8	50x130	844	
060		14	50x130	720	
061		1	50x65	600	
062		1	50x130	600	
063		1	50x130	563	
064		21	50x130	545	
065		2	50x130	469	
066		67	50x130	350	
067		1	50x130	350	
068		1	50x130	350	
069		2	50x65	350	
070		1	50x65	350	
071		7	50x130	340	
072		7	50x130	320	
073		1	50x65	188	
074		1	50x83	150	
AR8	Fundamentbalken		3	68x44	6004

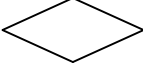
Pos	Schweden / 50 / 08	ST	F (mm)	L (mm)
AR2	Fundamentbalken 	2	68x44	4990
AR1	Fundamentbalken 	5	68x44	3732
AR6	Fundamentbalken 	2	68x44	2954
AR3	Fundamentbalken 	6	68x44	1832
AR9	Fundamentbalken 	5	68x44	1482
AR7	Fundamentbalken 	3	68x44	1396
AR4	Fundamentbalken 	3	68x44	1182
AR5	Fundamentbalken 	3	68x44	1018
PR6	Dachbalken 400 4900 400 	1	90x190	5800
PR5	Dachbalken 400 4900 400 	1	90x190	5800
PR1	Dachbalken 400 4900 400 	1	90x190	5800
PR3	Dachbalken 400 3380 	1	90x140	3830
PR4	Dachbalken 400 2420 	1	90x140	2870
PR2	Dachbalken 400 2420 	1	90x140	2870
075	Fussbodenbretter 	59	90x26	2998
076		42	90x26	1848
077	Terrassenbretter 	20	90x26	2248
078		33	90x26	698
079	Schlafbodenbretter 	22	90x20	3748
080		17	90x20	2998
081	Abdeckleiste 		20x40	36m
A1L	Fenster 810x910  Isoglas 672x608 Plekk 45x662		3L+1R	

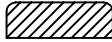
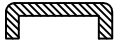
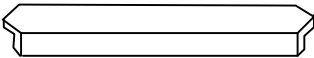
Pos	Schweden / 50 / 08	ST	F (mm)	L (mm)
A2L	<p>Fenster 1200x910</p>  <p>Isoglas 672x442 Plekk 45x495</p>	1		
U86L	<p>Tür 860x1950</p>  <p>Isoglas 1370x595</p>	1L		
U140L	<p>Tür 1400x1950</p>  <p>Isoglas 1370x469</p>	1		
US7	<p>Tür 700x1950</p> 	1L		
KOL	<p>Fenster 520x1500</p>  <p>Isoglas 430x1265</p>	1		

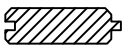
Pos	Schweden / 50 / 08			ST	F (mm)	L (mm)
086	Giebelzierbretter			4	110x20	2700
087				2	110x20	2300
088	Giebelbretter			4	90x20	2700
089				2	90x20	2300
090	Giebelbretter und Giebeldeckbretter			8	60x20	2700
091				4	60x20	2300
092	Segment			3		
093	Dachpappenleiste und Dachpappenfixierung				40x20	38 lfm
094	Handlauf			1	90x20	750
095				1	90x20	2300
096				1	90x20	380
097				1	90x20	1430
098				6	90x20	130
099	Terrasseneinfassung			2		845
100-103			1+1+1+1			1600
104	Leiter			2		
105				3		
106	Dreiecksild	L+R	2090x2143	1+1		
107	Dreiecksild	L+R	2490x1754	1+1		
108	Dachbretter			100	90x20	2490
109				48	90x20	2090
110	Trennleiste			1	50x26	1100
111				1	50x26	900